

Product datasheet:

Locking plug nickel-plated brass

Locking plugs nickel-plated brass

- with hexagon
- without O-Ring



Article no.:	➔ 8745.40
E-No:	126767800
EAN:	7611614229669
Delivery:	25

Dimensions / Form

Thread:	M40x1.5
Spanner size:	42 mm
Thread length L:	8 mm
Dimension H:	4.0 mm

Features

Thread type:	metric
Thread length:	short
Product type:	closing screw

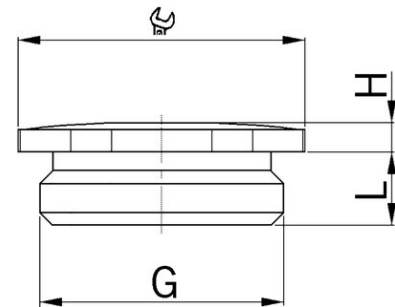

Approvals / Certifications

Protection class:	IP54
Protection class with condition:	IP68 (if connection thread is sealed)

Storage / Installation / Operation

Minimum operating temperature:	-40 °C
Maximum operating temperature:	200 °C